

Operating Instructions

1. **Intended use.** This Power Tool is intended for industrial applications, for cutting sheet metal (maximum capacity is indicated in the Specifications), for use with cutting jaws and cutting blades which are indicated in these operating instructions or recommended by DRÄCO

2. Initial Operation

Observe the rated voltage: The voltage of the power source must match that given on the nameplate of the machine. Chargers for 230V can also be operated on 220 V power sources.

Switching ON and OFF

Switching ON: Slide the switch (93) forward

Switching OFF: Slide the switch (93) to the rear.

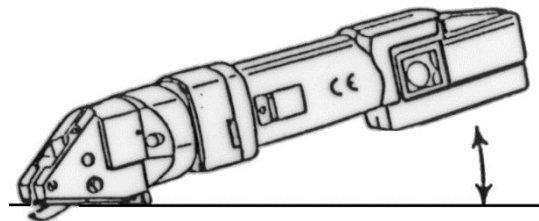

- The material to be cut must always be free of oil or grease.** Always place the machine flat on the work piece
- Cut-outs:** Drill a starting hole with a 12-14 mm diameter drill. **Circular cuts:** Always cut counter clockwise and from left to right.
- Do NOT cut sheet metal along welding points. Do NOT cut multi layer sheets, which exceed the maximum cutting capacity.
- Battery Change**
Before using the cordless tool, charge a new or empty battery. The full capacity is reached, after charging the battery about 4-5 times.

Care and Maintenance



Before working on machine disconnect from power supply by removing plug from socket. Always keep the machine and the ventilation slots clean. Oil the knife pin at regular intervals.

If the machine should happen to fail despite the care taken in manufacture and testing, repair should be carried out by an authorised customer services agent for DRÄCO power tools.

CE-Declaration of conformity

We declare under our sole responsibility that this product is in conformity with the following standards.

EC 98/37, EC 93/ 68 EWG, EC 04/108 EC, or standardisation documents DIN EN ISO 12100-1, DIN EN ISO 12100-2, EN 50 144, EN 55 014

CE 09 Max Draenert

Insert the battery (A)

Insert the battery from the back, until it clicks into place.



Abb. A



Abb. B

Remove battery (B)

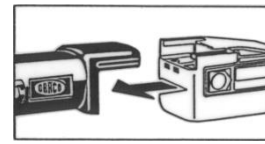
Press both stop locks together, take battery off, see arrow.

- For inside cutting**, if cutting a radius with the right hand, cut from right to left. The outside radius is unlimited.
- For **cutting out** curved or circular inside patterns, a 14 mm ($\pm 1/2$ ") hole, or a punched slot should be made to insert the centre cutter.
- If after cutting, a **small strip** remains this can easily be trimmed off to the exact measurement, without leaving a burr or any distortion of the material. Just one side of the cordless tools can be used for cutting also (e.g. along a marked line). Lift the power tools out of the shavings while the motor is running. Cut off longer shavings.
- Both knife and jaws can be sharpened. After being sharpened or replaced, the knife at it's lowest point should protrude the jaws by approximately 3 mm. The knife should have approximately 0,05 mm (0,005") play on each side of the jaws, centring the cutter with spacing shims supplied.
- Every 200 operating ours have the cutting blade and cutting jaws sharpened at a specialist workshop.
- Ensure that the material to be cut is free of oil and grease.**

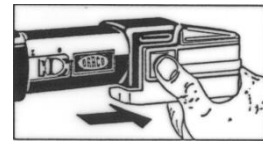
Warranty

DRÄCO tools carry a guarantee of 12 months from date of delivery.

Damage attributable to normal wear and tear, overload or improper handling will be excluded from the guarantee. (e.g. blades/knives and jaws)

In case of complaint please send the machine, **undismantled**, to your dealer or the DRÄCO Service Centre for electric power tools.

Environmental protection



Recycling raw materials instead of waste disposal.

Machine, accessories and packaging should be sorted for environment-friendly recycling.



Operating Instructions for the metal-shears AK3514-2, AK3514-7R, AK3520, AK3515

To avoid any disturbance please read the following instructions:

For your safety:



1 Safe operation of this machine is possible only when the operating instructions and the safety precautions are read completely and the instructions contained therein are strictly observed.

2 The machine must not be used when damp and must not be operated in a wet environment.

3 Always inspect cable and plug before using machine. Only have damage repaired by a qualified professional. Put the plug into the mains socket only when the machine is switched off.

4+5 Always wears protective goggles, protective gloves and heavy-duty shoes when working.

- Do not carry the machine by the cable.
- Always remove the plug from the power supply socket before carrying out any work on the machine, when interrupting work and when not using the machine.
- Always place the cable to the rear away from the machine.
- Apply the machine to the sheet metal only when switched on.
- Always provide for secure footing when working.
- Firmly clamp the work piece if it dose not remain stationary from its own weight.
- The knife should not rub on the jaws: Possible danger of cutting tool breakage.
- Do not exceed the maximum allowable material thickness especially when cutting over doublers, folded joints or welded seams.



For further notes on safety refer to enclosed sheet

Technical Data:

DRÄCO metal shears	AK 3520	AK 3514-2	AK 3514-7R	AK 3515
Art.no.	35201	351421	351471	35151
max. cutting capacity				
steel 400 N/mm ² mm	1,7	1,7	1,7	1,7
stainless steel 600 N/mm ² mm	1,3	1,3	1,3	1,3
stainless steel 800 N/mm ² mm	1,0	1,0	1,0	1,0
non ferro 250 N/mm ² mm	2,5	2,5	2,5	2,5
tightest radius \pm mm	200	200	45	200
working speed \pm m/min	4	4	4	4
strokes \pm min ⁻¹	1800	1800	1800	1800

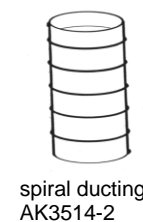

spiral ducting
AK3514-2

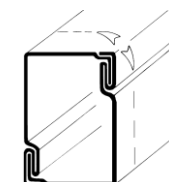

Pittsburgh-seam
AK3514-2

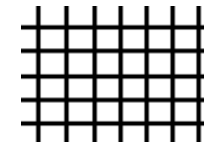

mesh and wire
AK3514-2

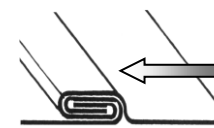

Eave
AK3514-2

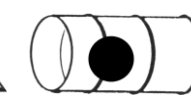

Inside cut outs
AK3514-7R

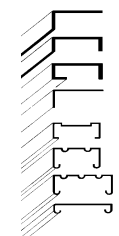

Formed parts + cable trays
AK3520,

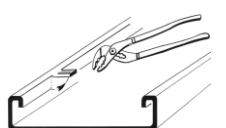

Exploded view DRÄCO AK-Serie Ni-Cd/Mh 12V

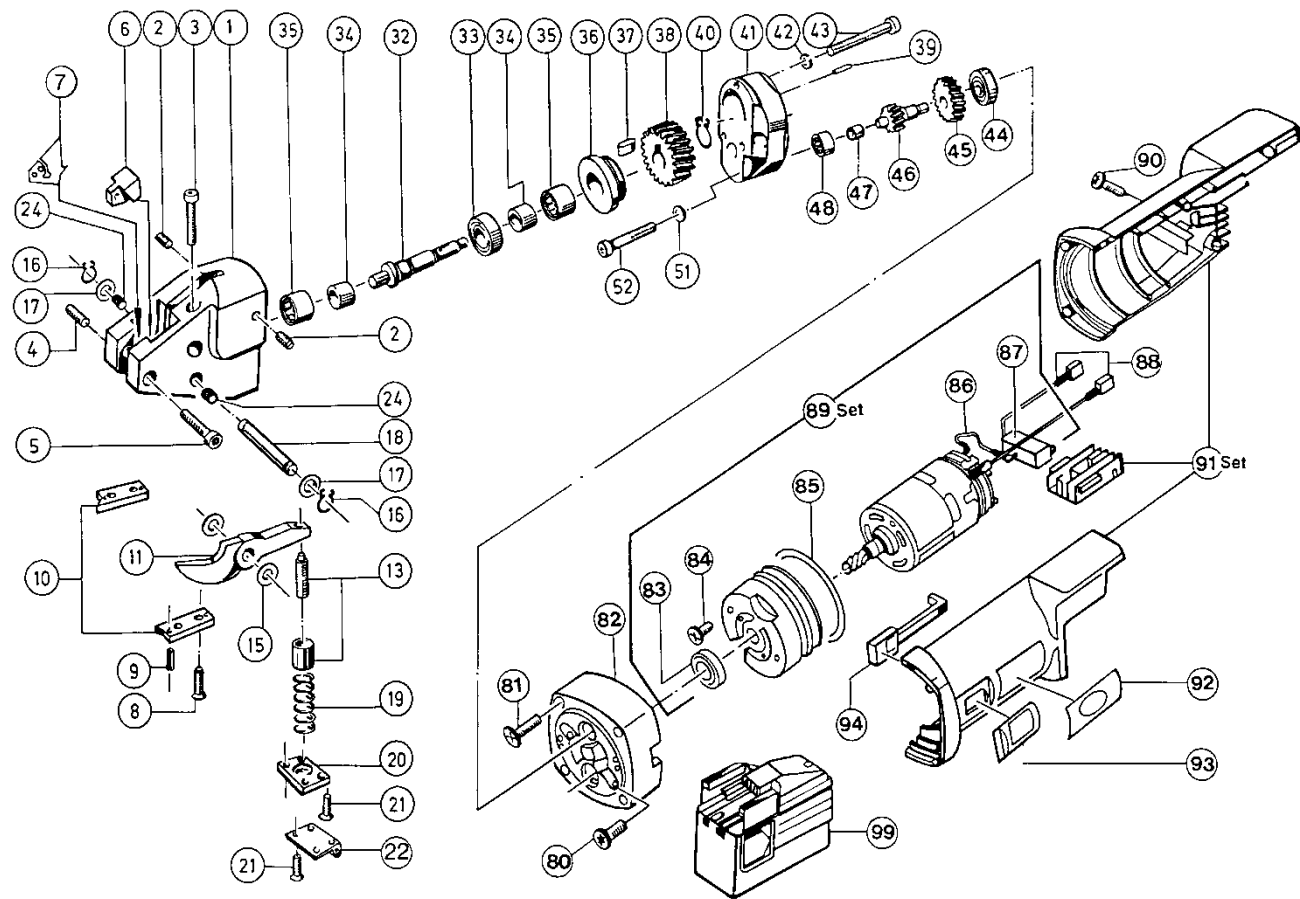

SERVICE TIPS

Before working on machine disconnect from power supply by removing plug from socket. Wear protective glasses!

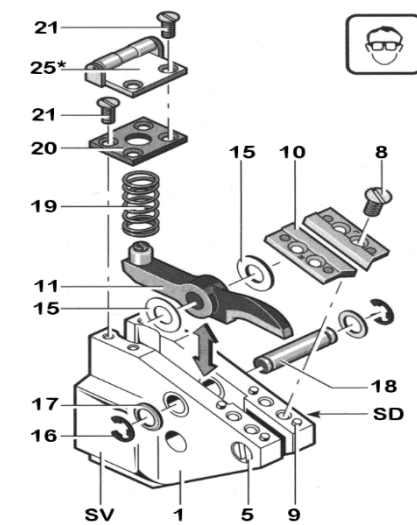

* Optional

- One drop of oil between knife (11) and head-casting (1) keeps the spacing shims (15) in place.
- Dismantle Spring cover (20) and take spring out (19)
- Take circlip (16) and washer (17) off.
- Push knife pin (18) out of casting.
- Take knife out of housing.
-  Attention, do not exchange the spacing shims (15).
- Place the knife inside the housing feed shims in on one side and push knife pin (18) into housing up to the middle of the knife.
- Feed the shims on the other of the knife.
- Push knife pin in completely, and secure washer (17) and circlip (16) again.
- Assemble spring (19) and spring cover (20).
- Between the knife (11) and the jaws (10) should be some distance, approximately 0,05 mm on each side. Knife (11) must be placed tight in the head casting.
- Adjustment for the play between the jaws. (a): 0,1 - 0,15 mm.

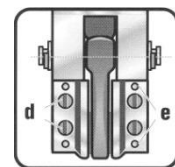
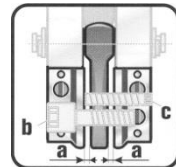
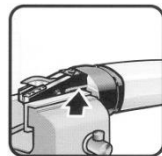

- If knife has contact with the jaws on both sides, adjust with screws in the head casting. If a burr is on the material, adjust the space between the knife and the jaws
- Replace jaws with a new set, loosen 4 screws (8) take jaws (10) and pins (9) off, assemble again and tighten with the screws.

Spare Parts List for DRÄCO Metal Shears AK3514-2, AK3514-7R, AK3520, AK3515

Pos.	Item	Pc.	Pos.	Item	Pc.		
1-43	35515	Shear head 3514-2 assembled	1	33	10250	Ball bearing	1
1-43	37515	Shear head 3514-7R assembled	1	34	10005	Sleeve	2
1-43	32364	Shear head 3520 assembled	1	35	10300	Needle Bearing	2
1	BG37547	Head Casting Pos. 1-3, 24,35	1	36	BG10450	Cap for Needle Bearing Pos. 35+36	1
2	81239	Tap Screw with ISK	2	37	10006	Key	1
3	81263	Screw	1	38	13051	Gear	1
4	81089	Tap Screw with ISK	1	40	10009	Circlip	1
5	81272	Flat Fillister Head Screw	1	41	13046	Gear Case Cover	1
6	10002	Spacing Block	1	42	81249	Securing Washer	3
6	BG37059	Spacing Block Pos.	1	43	81262	Flat Fillister Head Screw	3
8	81286	Flat Head Screw	4	44	13039	Ball Bearing	1
9	81248	Pin	4	45	13540	Gear 24 Z	1
				46	13041	Pinion 20 teeth	1
10	35146	Jaws AK 3514-2	1	47	13042	Sleeve	1
11	03514	Knife 3514	1	48	13043	Needle bearing	1
				51	81243	Spring washer	2
10	37222	Jaws AK 3514-7R	1	52	81031	Screw	2
11	37140	Knife 3514-7R	1	80	33080	Screw	1
				81	33081	Screw	1
10	35020	Jaws AK 3520	1	82	33082	Motor Cover	1
11	03520	Knife 3520	1	83	10038	Ball Bearing	1
				84	33084	Motor Cover	1
10	35146	Jaws AK 3515	1	85	33085	O-Ring	1
11	03515	Knife 3515	1	86	33086	Cable	1
				87	33087	Switch	1
15	BG12400	Spacing Shims Set	1	88	33088	Cable	1
16	81275	Circlip	2	89	33089	Motor cpl. (Pos.83-88)	1
17	81072	Washer	2	90	33090	Motor Cover	1
18	BG35145	Knife Pin Set	1	91	33091	Motor housing cpl.	1
18	12500	Spacing Shims	1	92	33092	Lable	1
19	12200	Spring	1	93	33093	Cap for switch	1
20	12300	Spring Cover	1	94	33094	Switch pad	1
21	81285	Flat Head Screw	4	99	31298S3	High Capacity Battery Pack MXL	
24	35542	Knife pin bushing	2		31297	SRA Charger 220V-240V 60 min.	
32	BG33018	Drive shaft Pos.34-38,40	1		31309	SRU Charger 115V USA/CDN 30 min.	
32	BG35556	Eccentric Shaft Pos.32,33,34,37+40	1				
32	35556	Eccentric Shaft	1				
			1				

Ordering spare parts please mention order and item number.

Max Draenert GmbH & Co.KG Electric - Cordless - Pneumatic Tools - Machines Germany

Factory I: **Administration** D-73777 Deizisau P.O.Box 1120 Phone **+49-7153-8217-0**
Manufacturing Shears D-73779 Deizisau Gutenbergstrasse 15-17 Fax **+49-7153-8217-66**
 Factory II: **Manufacturing** D-73779 Deizisau Seewiesenweg 1
Roofing System

Internet: <http://www.dracotools.com>

e-mail: draenert@dracotools.com